

ARM Series

Modbus Sensor Connector Type Digital Remote I/O

■ Features

- Modbus RTU standard protocol
- Saving work time for wiring with sensor connector (CNE series, sold separately)
- Compact size
 - : Small size with W26×L76×H54mm to install at narrow space
 - : Available DIN Rail mounting and bolt mounting method
- Low-speed (16-bit/30CPS) counter function
- Real-time monitoring by various functions
 - : Communication speed auto-recognition
 - : Reading number of expansion units and specifications,
 - Reading model name of basic and expansion units
 - : Monitoring Single byte input/output, Multi byte input/output and status Flag
- Easy expansion
 - : Available to connect up to 63 basic units per 1 master unit
 - : Available to connect up to 7 expansion units per 1 basic units (controllable input/output for max. 64 points)
 - : Combines the desired specifications of input/output by various input/output units
 - : Organizes power and communication system by only communication cable lines
- High reliability
 - : Built-in surge, short, overheat, reverse power polarity and static prevention circuits



⚠ Please read "Safety Considerations" in the instruction manual before using.



■ Ordering Information

AR	M	-	D	I	08	N	-	4S		
Item										
Network										
Digital/Analog										
I/O type										
I/O points										
I/O specifications										
Terminal block										
									4S	Sensor connector type (4-pin socket)
									N	NPN open collector
									P	PNP open collector
									08	8 points type
									I	Input type
									O	Output type
									D	Digital type
									M	Basic unit (Modbus RTU)
									X	Expansion unit (DeviceNet/Modbus)
									AR	Autonics Remote I/O

■ Models

Models		Specification
Basic unit	Expansion unit	
ARM-DI08N-4S	ARX-DI08N-4S	10-28VDC NPN input 8-point, low-speed counter (10mA/point)
ARM-DI08P-4S	ARX-DI08P-4S	10-28VDC PNP input 8-point, low-speed counter (10mA/point)
ARM-DO08N-4S*	ARX-DO08N-4S*	10-28VDC NPN output 8-point, low-speed counter (0.3mA/point)
ARM-DO08P-4S*	ARX-DO08P-4S*	10-28VDC PNP output 8-point, low-speed counter (0.3mA/point)

※Low speed counter of digital output type is available only when using with digital input type.

■ Manual

For the detail information and instructions of communication setting and Modbus mapping table, please refer to user manual for communication, and be sure to follow cautions written in the technical descriptions (catalog, website). Visit our website (www.autonics.com) to download manuals.

Modbus Digital Remote I/O

■ Specifications

Model	Basic unit	ARM-DI08N-4S	ARM-DI08P-4S	ARM-DO08N-4S	ARM-DO08P-4S
	Expansion unit	ARX-DI08N-4S	ARX-DI08P-4S	ARX-DO08N-4S	ARX-DO08P-4S
Power supply	Rated voltage: 24VDC \equiv , Voltage range: 12-28VDC \equiv				
Power consumption	Max. 3W				
I/O points	NPN input 8-point		PNP input 8-point	NPN output 8-point	PNP output 8-point
Control I/O	Voltage	10-28VDC \equiv input		10-28VDC \equiv output (voltage drop: max. 0.5VDC \equiv)	
	Current	10mA/point (sensor current: 150mA/points)		0.3A/point (leakage current: max. 0.5mA)	
	Common	8 points, Common			
Special function (input)	Counter for 16-bit (30CPS \times ¹) (only when using digital input unit of ARM, ARX)				
Communication speed \times ²	2400, 4800, 9600, 19200, 38400, 57600, 115200bps (default: 9600bps)				
Communication method	2-wire half duplex				
Communication distance	Max. 800m				
Multi-drop	Max. 32 multi-drop				
Medium access	POLL				
Application standard	Compliance with EIA RS485				
Protocol	Modbus RTU				
Data bit	8-bit				
Stop bit	1-bit or 2-bit (default: 2-bit)				
Parity bit	None/Odd/Even (default: none)				
Isolation method	I/O and inner circuit: photocoupler insulation Modbus to internal bus and inner circuit: insulation Unit power: non-insulation				
Insulation resistance	Over 200M Ω (at 500VDC megger)				
Noise immunity	\pm 240V the square wave noise (pulse width: 1 μ s) by the noise simulator				
Dielectric strength	1,000VAC 50/60Hz for 1 min				
Vibration	1.5mm amplitude at frequency of 10 to 55Hz (for 1 min) in each X, Y, Z direction for 2 hours				
Shock	500m/s ² (approx. 50G) in each X, Y, Z direction for 3 times				
Environment	Ambient temp.	-10 to 55°C, storage: -25 to 75°C			
	Ambient humi.	35 to 85%RH, storage: 35 to 85%RH			
Protection structure	IP20 (IEC standards)				
Protection circuit	Surge, short-circuit, overheat (over 165°C) and ESD protection, reversed polarity protection circuit				
	Overcurrent protection circuit (operated at min. 0.17A)			Overcurrent protection circuit (operated at min. 0.7A)	
Indicator	Network status (NS) LED (green, red), unit status (MS) LED (green, red) I/O status LED (input: green, output: red)				
Material	Front case, body case: Polycarbonate				
Mounting	DIN rail or bolt mounting type				
Approval	CE				
Weight \times ³	Basic	Approx. 123.3g (approx. 61.8g)	Approx. 123.3g (approx. 61.8g)	Approx. 123.3g (approx. 61.8g)	Approx. 123.3g (approx. 61.8g)
	Expansion	Approx. 117.5g (approx. 56g)	Approx. 118.5g (approx. 57g)	Approx. 119.5g (approx. 58g)	Approx. 120.5g (approx. 59g)

\times 1: CPS (counter per second): Specification of accepting external signals per second

\times 2: The communication speed is automatically set to the communication speed of the Master (PC, PLC, etc.).

When changing the communication speed during operation, the network status (NS) LED flashes in red and communication is not possible.

\times 3: The weight includes packaging. The weight in parenthesis is for unit only.

\times Environment resistance is rated at no freezing or condensation.

SENSORS

CONTROLLERS

MOTION DEVICES

SOFTWARE

(J) Temperature Controllers

(K) SSRs

(L) Power Controllers

(M) Counters

(N) Timers

(O) Digital Panel Meters

(P) Indicators

(Q) Converters

(R) Digital Display Units

(S) Sensor Controllers

(T) Switching Mode Power Supplies

(U) Recorders

(V) HMIs

(W) Panel PC

(X) Field Network Devices

ARM Series

■ Unit Descriptions

◎ Basic unit

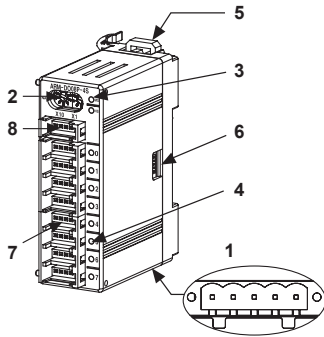

1. Network connector

No.	For	Organization
5	24VDC (+)	
4	GND	
3	N-C	
2	B	
1	A	

- 2. **Rotary switch for address:** Rotary switch for setting the address ×10 represents tens digit and ×1 represents ones digit.
- 3. **Status LED:** It displays the status of unit (MS) and network (NS).
- 4. **I/O status LED:** It displays each I/O status.
- 5. **Rail lock:** It is used for mounting DIN rail or with bolts.
- 6. **Connector output part:** It connects an expansion unit.
- 7. **Sensor connector:** It is used for connecting external device I/O.
- 8. **External power connector:** It is used for supplying external power.

◎ Expansion unit

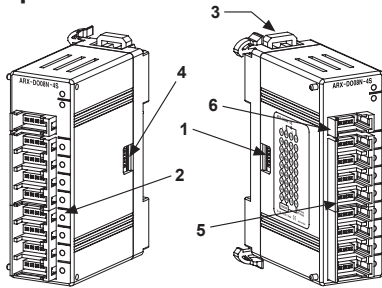

- 1. **Connector input part:** It connects expansion unit and is joined into the expansion connector output.
- 2. **I/O status LED:** It displays each I/O status.
- 3. **Rail lock:** It is used for mounting DIN rail or with bolts.
- 4. **Connector output part:** It connects an expansion unit.
- 5. **Sensor connector:** It is used for connecting external device I/O.
- 6. **External power connector:** It is used for supplying external power.

■ Status LED

(☀: ON, ✨: Flash, ●: OFF)

Item	LED status		Description
	Red	Green	
Unit status (MS) LED	☀	●	Error of expansion units
	✨	●	Error of MAC ID
	●	☀	Normal operation
	●	●	Power is not supplied
Network status (NS) LED	☀	●	Not supported communication speed (at auto baud rate)
	✨	●	Error of packet
	●	☀	Normal communication
	●	✨	Communication standby

Modbus Digital Remote I/O

I/O Circuit Diagram

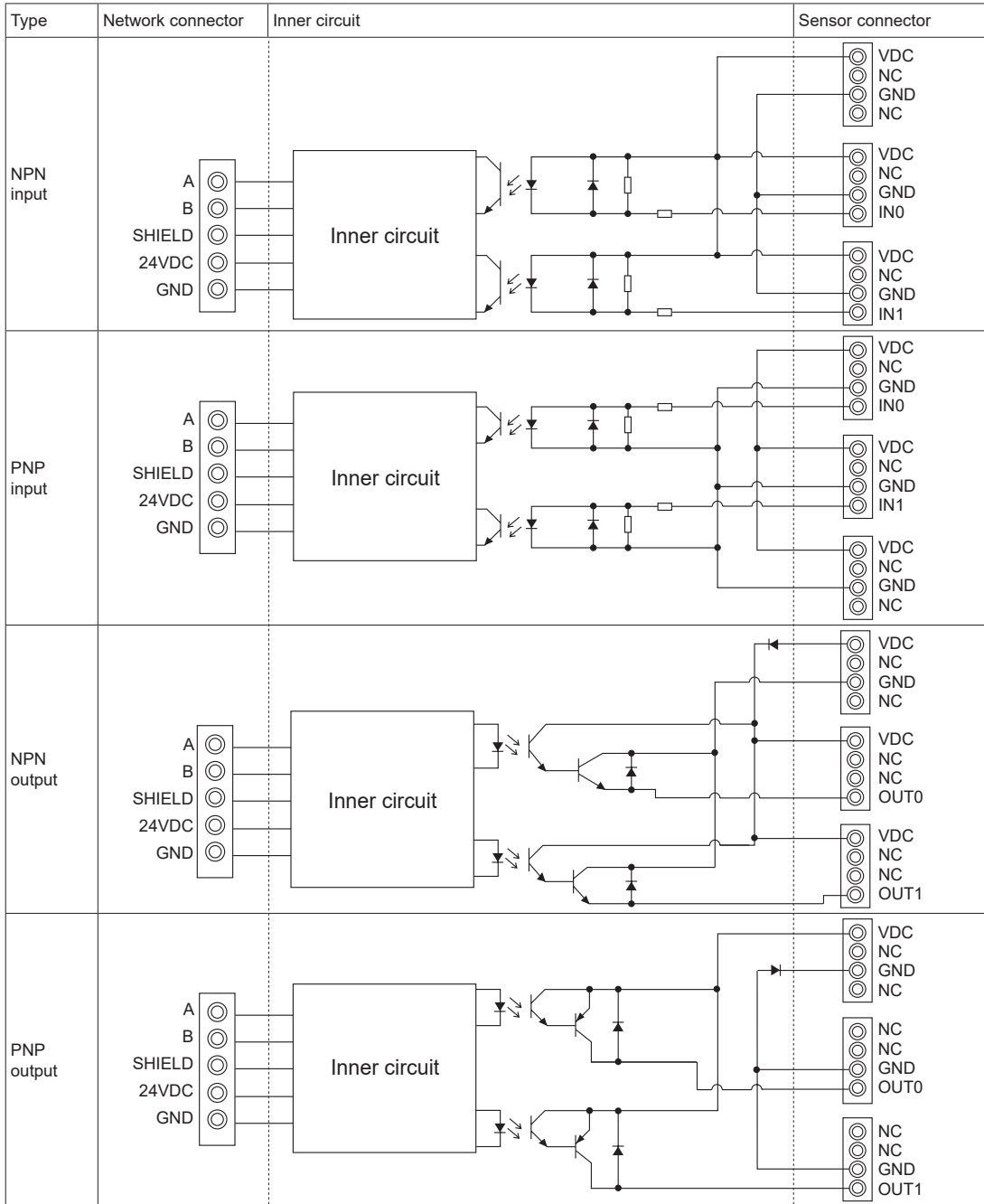

- SENSORS
- CONTROLLERS
- MOTION DEVICES
- SOFTWARE
- (J) Temperature Controllers
- (K) SSRs
- (L) Power Controllers
- (M) Counters
- (N) Timers
- (O) Digital Panel Meters
- (P) Indicators
- (Q) Converters
- (R) Digital Display Units
- (S) Sensor Controllers
- (T) Switching Mode Power Supplies
- (U) Recorders
- (V) HMIs
- (W) Panel PC
- (X) Field Network Devices

ARM Series

■ Connections

※When wiring the communication connector, use AWG20 cable and tighten the connector screw with a tightening torque of 0.5N·m.

- ARM-DI08N-4S
- ARX-DI08N-4S

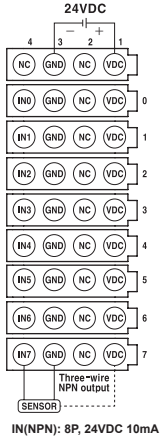

- ARM-DI08P-4S
- ARX-DI08P-4S

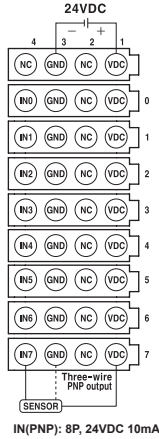

- ARM-DO08N-4S
- ARX-DO08N-4S

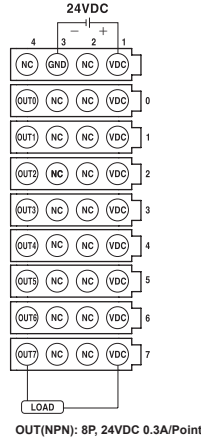

- ARM-DO08P-4S
- ARX-DO08P-4S

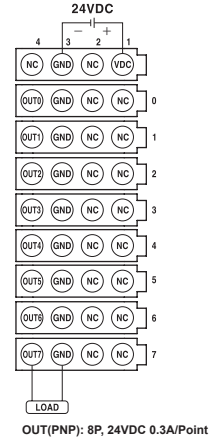

■ Terminating Resistance

- 120Ω
- 1% of metallic film
- 1/4W

※Connect terminating resistances on the both ends of the network cables. If not connecting terminating resistances, impedance can be too high or low. It may cause network problems.

■ Dimensions

※Same dimensions are applied to both basic and expansion unit.

(unit: mm)

※Tightening torque for mounting bolts: 1.8 to 2.5N·m

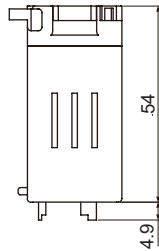

- Expansion connector
(supplied only for expansion unit)

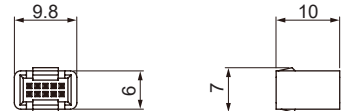

- Rail lock position:
mounting with bolt

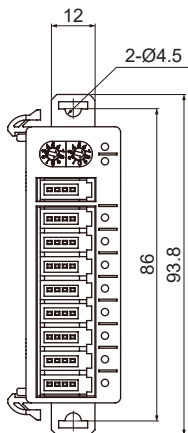

- Rail lock position:
mounting on DIN rail

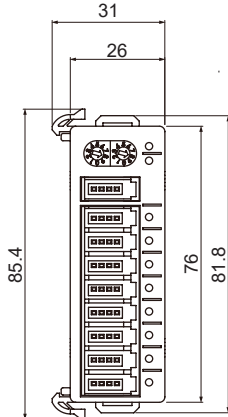

- Panel cut-out

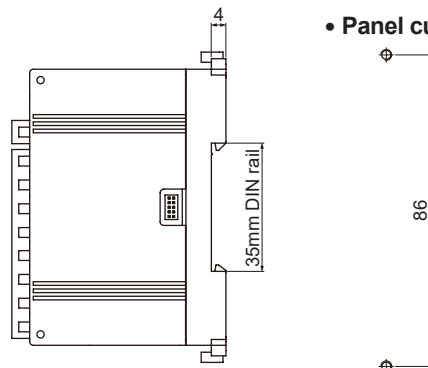

■ Setup and Installation

◎ Setting node address

-Setting address is able to be done by rotary switch for address, or by in the EEPROM.

-If the rotary switch for address' number is "00", the address is available to set by in the EEPROM.

The others, the desired number of rotary switch is that address.

- The address of the connected unit must not be duplicated.

When changing the address during operation, the unit status (MS) LED flashes in red and the unit communicates to the address before the change.

● By rotary switch for address

① Two rotary switches are used for setting address. The X10 switch represents tens digit and the X1 switch represents ones digit. The address can be set 01 to 99.

② After setting the desired address, re-supply the unit power for applying the changed address.

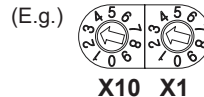

The X10 and X1 switches point both at "3", the address is "33".

● By in the EEPROM for address

① During communicate status with master system (PLC or PL), set the desired address on the 41029 EEPROM MAC ID parameter.

② The set address is changed after unit power is supplied. Re-supply the unit power for applying the changed address.

◎ Unit Installation

● Mounting on panel

① Pull two Rail locks on the rear part of a unit, there is a fixing bolt hole.

② Place unit on a panel to be mounted.

③ Make a hole on a fixing bolt hole position.

④ Fasten the bolt to fix the unit tightly. Please set the tightening torque under 0.5N·m.

● Mounting on DIN rail

① Pull two Rail locks on the rear part of a unit.

② Place the unit on DIN rail to be mounted.

③ Press Rail locks to fix the unit tightly.

● Connection of basic and expansion units

① Turn OFF the power of a basic unit.

② Remove the cover of connector for extension with nippers.

③ Connect connector input part of an expansion unit and connector output part of a basic unit with the connector which is enclosed with an expansion unit box.

④ Connected expansion units are installed as the right figure.

⑤ Supply power to the basic unit.

※ Re-supply power to the basic unit, and it recognizes expansion units.

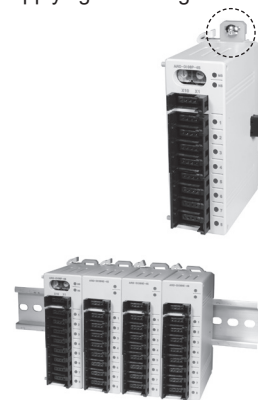

■ Cautions during Use

1. Follow instructions in 'Cautions during Use'. Otherwise, it may cause unexpected accidents.

2. 24VDC power supply should be insulated and limited voltage/current or Class 2, SELV power supply device.

3. Use only designated connector and do not apply excessive power when connecting or disconnecting the connectors.

4. Keep away from high voltage lines or power lines to prevent inductive noise. In case installing power line and input signal line closely, use line filter or varistor at power line and shielded wire at input signal line. Do not use near the equipment which generates strong magnetic force or high frequency noise.

5. Do not connect or disconnect the expansion unit when power is being supplied.

6. This unit may be used in the following environments.

① Indoors (in the environment condition rated in 'Specifications')

② Altitude max. 2,000m

③ Pollution degree 2

④ Installation category II

SENSORS

CONTROLLERS

MOTION DEVICES

SOFTWARE

(J) Temperature Controllers

(K) SSRs

(L) Power Controllers

(M) Counters

(N) Timers

(O) Digital Panel Meters

(P) Indicators

(Q) Converters

(R) Digital Display Units

(S) Sensor Controllers

(T) Switching Mode Power Supplies

(U) Recorders

(V) HMIs

(W) Panel PC

(X) Field Network Devices